

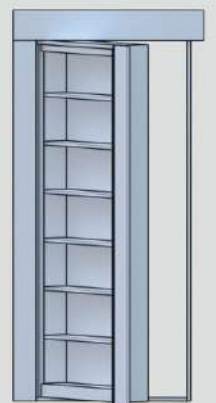

# MADERRA

Hidden Bookshelf Doors

INSTALLATION INSTRUCTIONS.



# INSTALLATION INSTRUCTIONS.

Please read this entire manual before you begin.

## ⚠️ WARNING!

This product contains small parts that can be a choking hazard. Do not let children play with any of these small parts! Keep children away from the work area during installation.

## ⚠️ CAUTION!

This product is intended to be installed by professional installation contractors or persons familiar with the tools and methods required for this installation. If you are not sure about your ability to perform this installation, you must contact a professional. Madera is not responsible for damage or injury caused by incorrect installation or improper use.

## ⚠️ CAUTION!

Do not use this product in any way, or for any purpose, that is not specifically described in these instructions. Madera is not responsible for damage or injury caused by incorrect installation or improper use.

## ⚠️ CAUTION!

Two people required for some parts of the installation process.

## SUMMARY - INSTALLATION INSTRUCTIONS BROCHURE

|  |   |
|--|---|
| A. Remove old door.....                            | 2 |
| B. Take out Bookshelf Door from pallet.....        | 3 |
| C. Install Bookshelf Door Frame.....               | 4 |
| D. Attach Bookcase to the Bookshelf Door Frame.... | 4 |
| E. Make Final Adjustments.....                     | 5 |
| F. Lock Mechanism System.....                      | 5 |

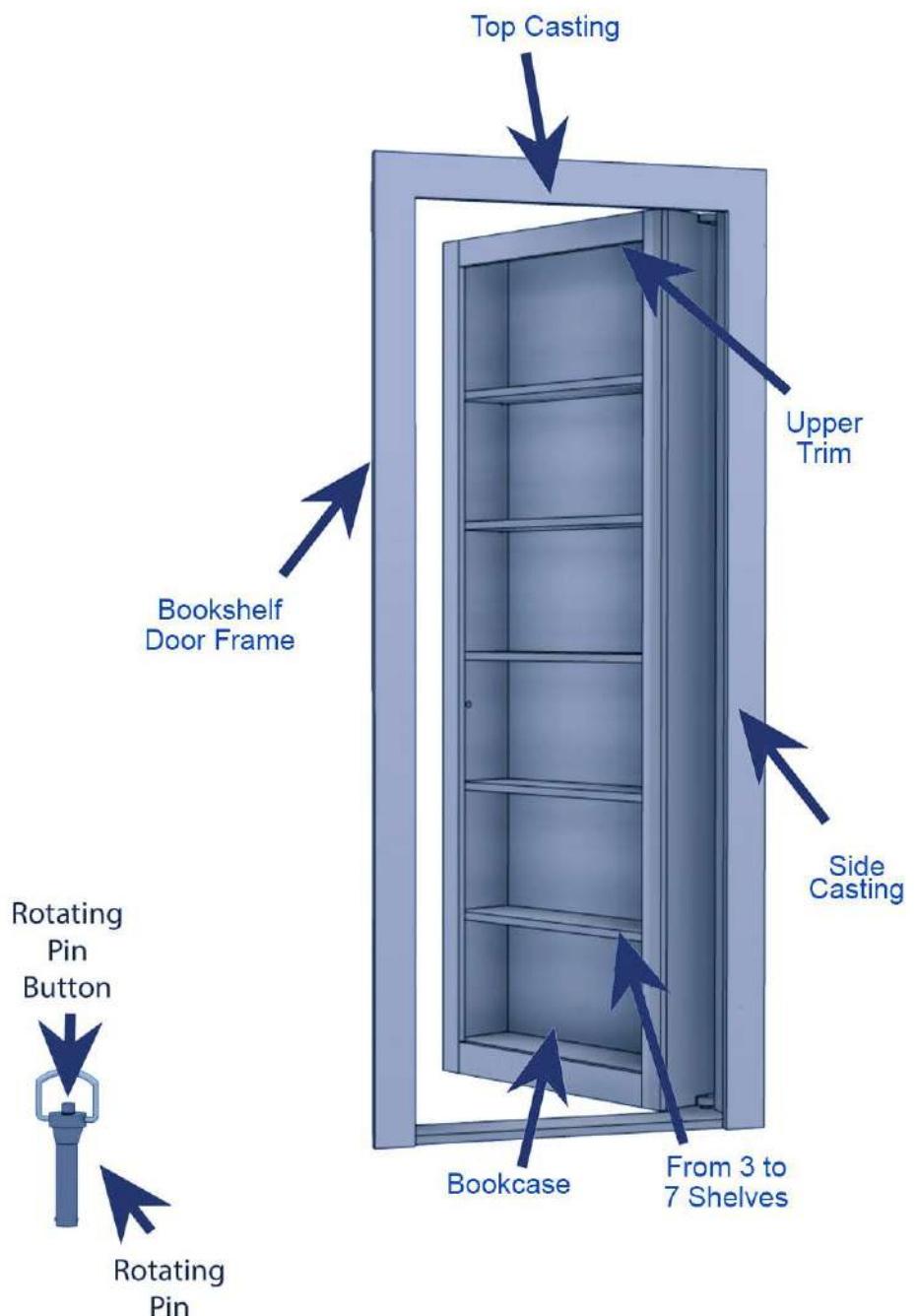

## A. Remove old door:

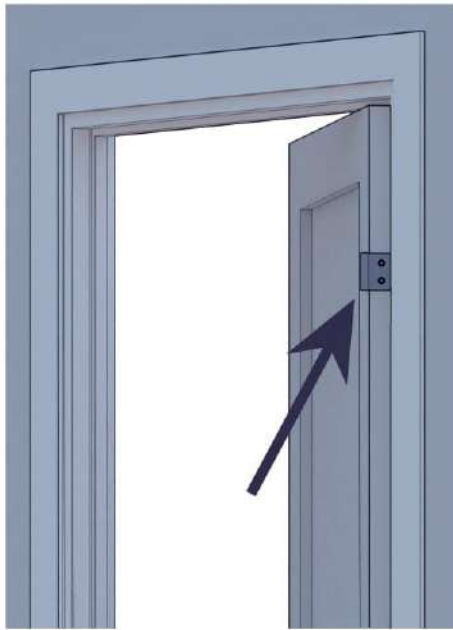

1. Remove Hinges and Door.



2. Remove Door Stops.

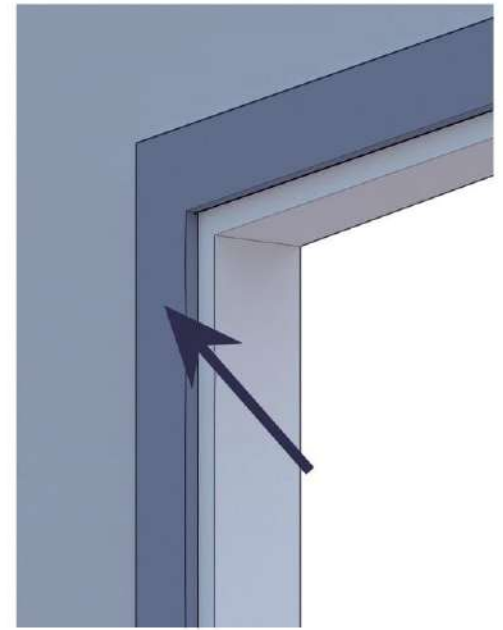

3. Remove Door Casing.

## B. Take out Bookshelf Door from pallet:

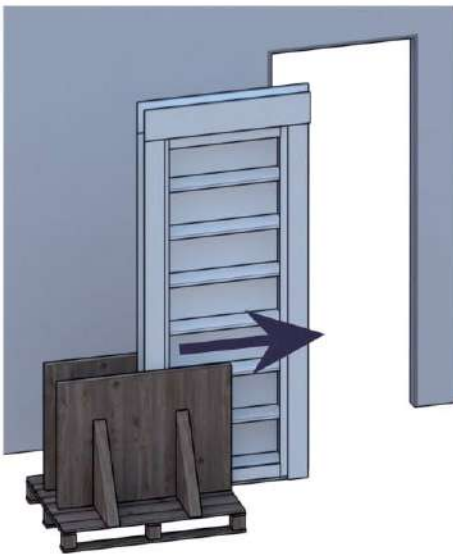

1. Remove the Bookshelf Door by sliding it off the pallet.

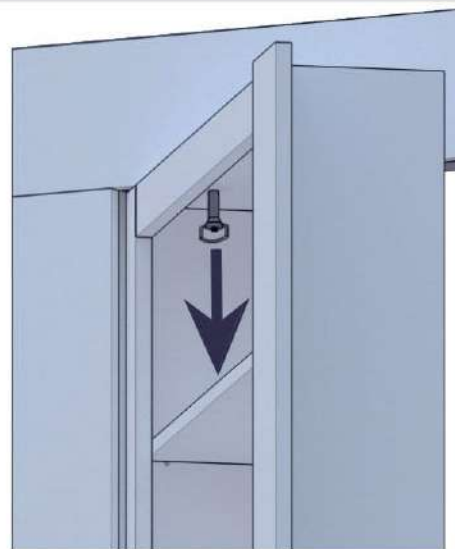

2. Detach Bookcase from Bookshelf Door Frame by removing Rotating Pin. You will need to push the Pin Button and pull the Pin out to remove it.

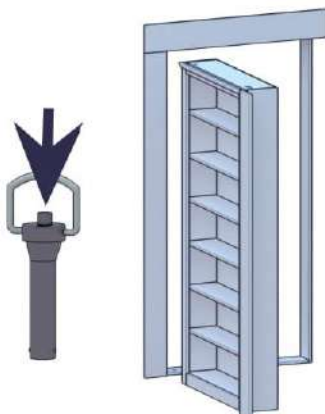

4. Place the Bookcase in a safe position. Put aside the Pin until later.

### ⚠ CAUTION!

Two people are required for this whole part of the installation process.

### ⚠ CAUTION!

Keep children away from the work area during installation.

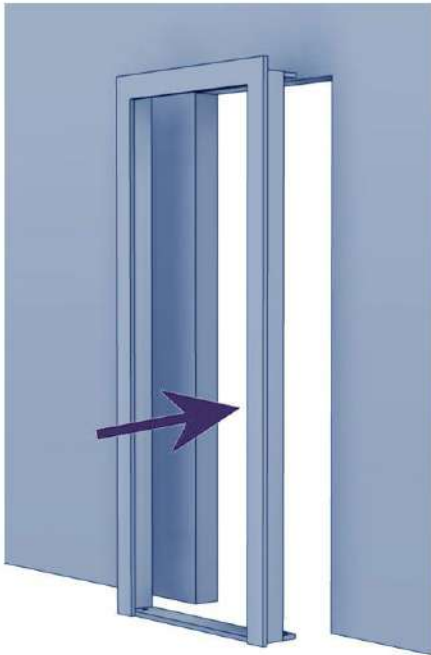

1. Insert the Bookshelf Door Frame into your door entrance.  
 \* By this point, your door entrance should NOT have Door Stops and Door Casing.

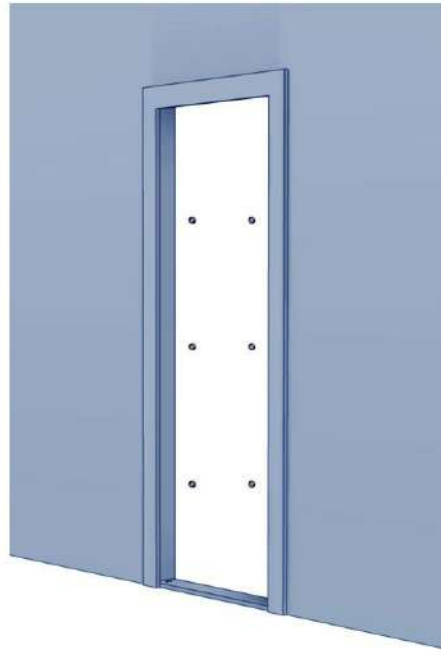

2. Place screws on the side frame of your door, so it attaches to your existing door frame.



3. If the wall or your existing rough opening or door frame is not leveled or straight, you will need to shim the door to level it.

#### D. Attach Bookcase to the Bookshelf Door Frame:



1. Place the Bookcase in position by aligning the bottom shaft into the rotating pivot mechanism.

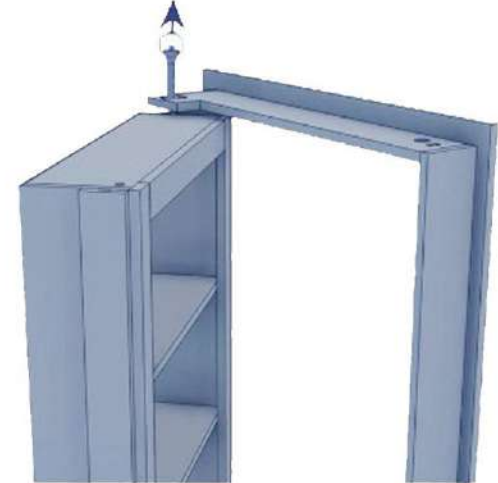

3. Align the upper Bookcase Pin Hole with the Frame Hole and insert the pin by pushing the pin bottom.

## F. Lock Mechanism - Electromagnetic System



1. For an easy installation experience, we send all our Lock Mechanisms already installed to the Bookshelf Door.

### 2. TROUBLE SHOOTING

In case your door does not lock, we recommend the following:

Check to make sure the wires are securely tightened to the correct terminal block

Check that the power supply is connected and operating properly

Make sure the lock switch is wired correctly



3. If you order cabinet hardware, now is the time to install them.

### **WARNING!**

Maderra recommends a licensed and trained electrician whenever wiring is involved.

Customer Support 866-346-8924 [Contactmaderra@gmail.com](mailto:Contactmaderra@gmail.com) 5.

# Push Button Electromagnetic Wire Diagram

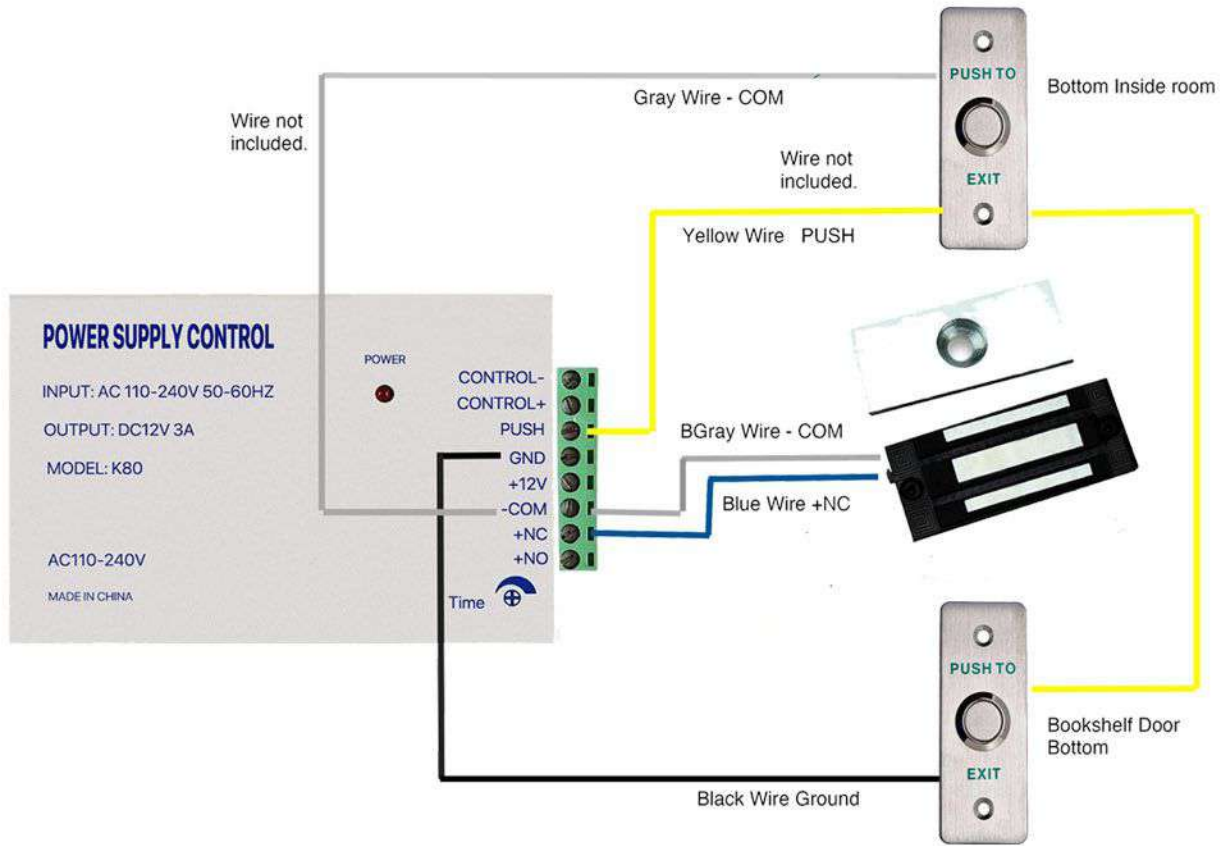

# Electromagnetic Finger Print Reader Wire Diagram

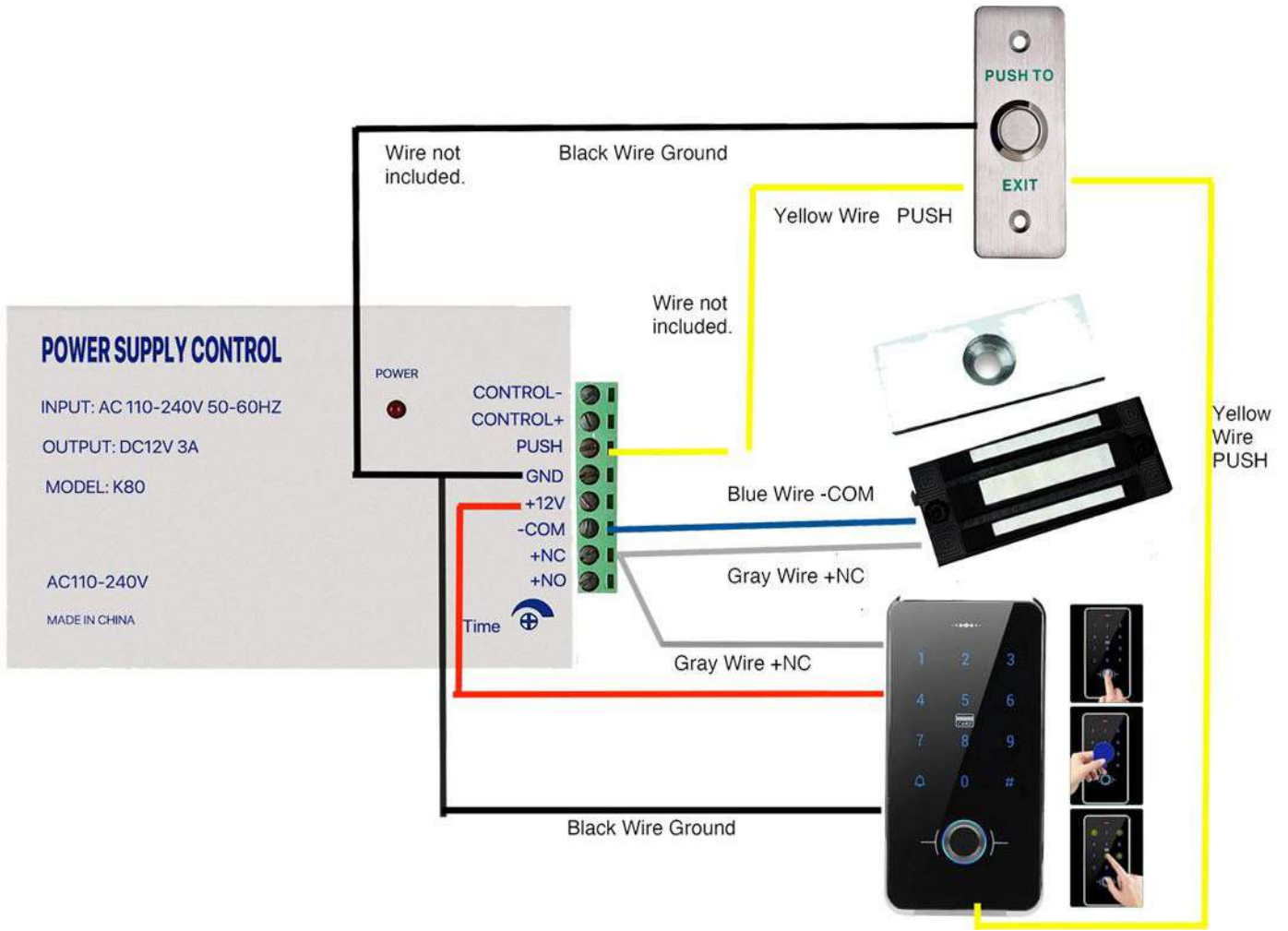

### Add a finger print

- Step 1 - Press: #
- Step 2 - Enter Programing Password: 123456
- Step 3 - Enter: 1
- Step 4 - Enter 001
- Step 5 - Press Fingerprint 3 times

If you want to add additional user, repeat the same steps mentioned in the step above with the exception of step 4. Each new additional the number you type will increase by one number.

Example: For a second user, you will enter 002. For a third user you will enter 003. For a forth user you will enter 004. You can add upto 125 user



### Add a cards or key fobs

- Step 1 - Press: #
- Step 2 - Enter Programing Password: 123456
- Step 3 - Enter: 1
- Step 4 - Enter 001
- Step 5 - Swipe Card or fob

If you want to add additional cards or fobs, repeat the same steps mentioned in the step above with the exception of step 4. Each new card or fob the number you type will increase by one number.

Example: For a second card/fob, you will enter 002. For a third card/fob you will enter 003. For a forth card/fob you will enter 004. You can add upto 125 cards/fobs.



### Modify Opening Password

- Step 1 - Press: #
- Step 2 - Enter Programing Password: 123456
- Step 3 - Enter: 2
- Step 4 - Enter: ( Enter a 4 digit Password of your choice)
- Step 5 - Re enter the the password you created in step 4



FACTORY PASSWORD **7890**  
PROGRAMMING PASSWORD **123456**



CAN REGISTER UP TO 125 USERS